

RustMo2 - Plant Layout

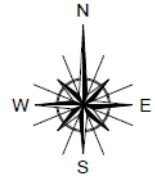





OVERALL MODULE LAYOUT
 SCALE 1: 5000

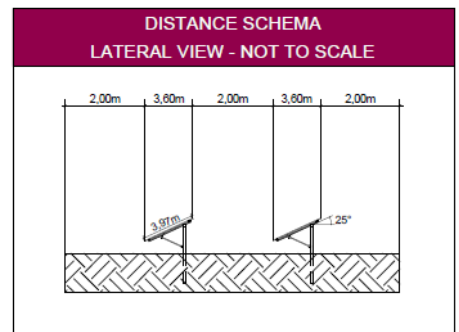

Rustmo 2

PROJECT:	
LATITUDE	25° 44' 29,47" S
SITE AREA	14,15 ha
PV AREA	13,05 ha
ROW TO ROW CLEARANCE	2 m
MODULE TILT	25°
NUMBER OF MODULES	42.624
INSTALLED CAPACITY	10 MWp
NUMBER OF ARRAYS	888
ARRAY TYPE	BYD 4 x 12
POWER / ARRAY	11,28 kWp
BASIS FOR PLAN	DWG NOT APPROVED
TECHNOLOGY	
MODULE	BYD
MODULE POWER	235 Wp
MODULE DIMENSIONS	1200 x 600 mm
INVERTER	16 SMA SC 630CP



LEGEND	
	ARRAY
	POWER STATION (2xSMA)
	SHADED AREAS
	FENCE
	PV AREA
	SITE BOUNDARY

